

# BURTON JAMES

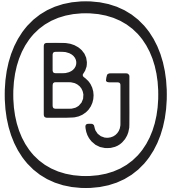

## ALTERNATIVES

EFFORTLESS STYLE, ENDLESS CUSTOMIZATION



PERFECTLY STYLISH,  
PERFECTLY COMFORTABLE,  
**PERFECTLY**  
**YOU**

Our **ALTERNATIVES** program, widely acclaimed as our most popular program among designers, distinguishes itself by offering the widest array of configurations, along with the option to select your depth and height.

Featuring a selection of arm styles, base and leg options, and back and seat cushion styles, **ALTERNATIVES** offers you the ability to create the spaces you dream of.

For questions, more information, or to request a custom quote, contact your sales representative or visit [BURTONJAMES.COM](http://BURTONJAMES.COM).



## STANDARD FEATURES

- Cloud 9 Seat Cushions
  - Blend Down Back Cushions
  - 8 Gauge Sinuous Springs
  - Solid Kiln-Dried Wood Frame
  - 20×20 Throw Pillows Included with Most Configurations
- All Pieces Available In:
    - Overall Depths: 36", 38", and 40"
    - Overall Back Heights: 34", 36", and 38"
    - Seat Height: 19"
    - Seat Cushions: 27"W
      - #10 Chair Cushion is 23"W
      - #22 Small Sofa Cushion is 30"W

## STEP 1: CHOOSE YOUR STYLE, DEPTH, AND HEIGHT

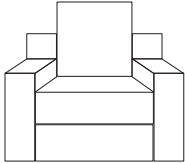
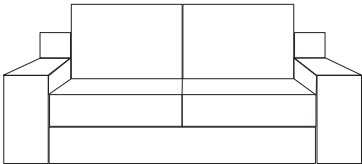
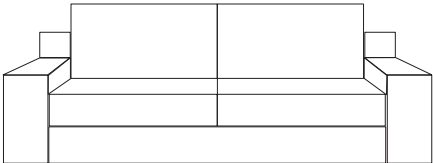
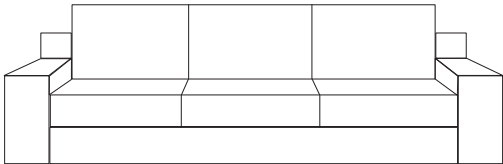
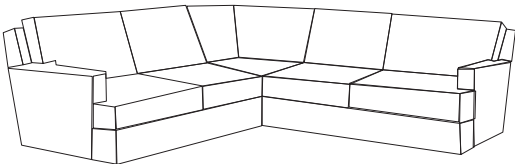
STYLE	OVERALL DEPTH	OVERALL HEIGHT
 <input type="checkbox"/> #10 - 23" Chair + Arms <input type="checkbox"/> #11 - Swivel Base UPCHARGE	<input type="checkbox"/> 36" (20" Seat Depth) <input type="checkbox"/> 38" (22" Seat Depth) <input type="checkbox"/> 40" (24" Seat Depth)	<input type="checkbox"/> 34" <input type="checkbox"/> 36" <input type="checkbox"/> 38"
 <input type="checkbox"/> #20 - 54" Loveseat + Arms	<input type="checkbox"/> 36" (20" Seat Depth) <input type="checkbox"/> 38" (22" Seat Depth) <input type="checkbox"/> 40" (24" Seat Depth)	<input type="checkbox"/> 34" <input type="checkbox"/> 36" <input type="checkbox"/> 38"
 <input type="checkbox"/> #22 - 60" Small Sofa + Arms	<input type="checkbox"/> 36" (20" Seat Depth) <input type="checkbox"/> 38" (22" Seat Depth) <input type="checkbox"/> 40" (24" Seat Depth)	<input type="checkbox"/> 34" <input type="checkbox"/> 36" <input type="checkbox"/> 38"
 <input type="checkbox"/> #30 - 81" Sofa + Arms	<input type="checkbox"/> 36" (20" Seat Depth) <input type="checkbox"/> 38" (22" Seat Depth) <input type="checkbox"/> 40" (24" Seat Depth)	<input type="checkbox"/> 34" <input type="checkbox"/> 36" <input type="checkbox"/> 38"
 <input type="checkbox"/> Sectional	<div style="border: 1px solid black; padding: 10px; width: fit-content; margin: 0 auto;"> <p><b>SELECT SECTIONAL PIECES AT STEP 9.</b></p> </div>	

## STEP 2: CHOOSE YOUR ARM

Select welting options at step 8. Contrast welting subject to upcharge. All arm options are 24"H.

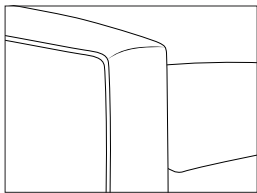

**4" Track Arm**

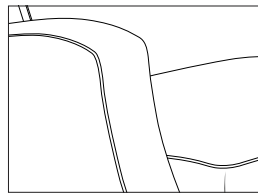

**4" Deco Arm**

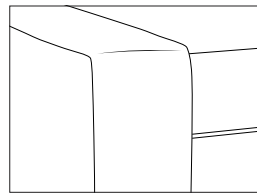

**6" Track Arm**

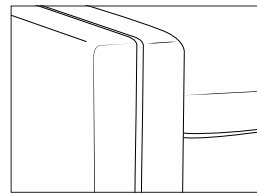

**6" Split Track**  
*Includes ¼" Standard Welt*

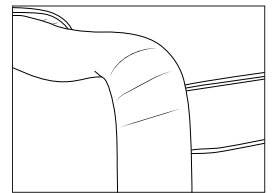

**6" English Arm**

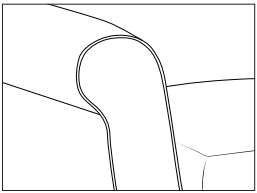

**6" Dorset Arm**  
*Arm post is 3½"W*

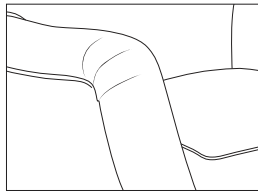

**6" Bentley Arm**

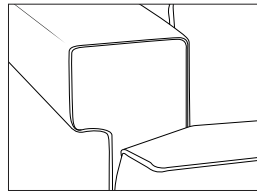

**6" Grand Arm**  
*Arm post is 4"W*

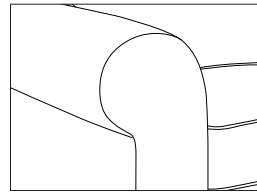

**8" Sock Arm**  
*Arm post is 6"W*

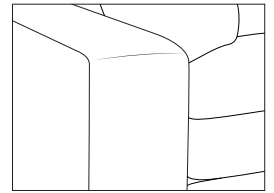

**9" Track Arm**

## STEP 3: CHOOSE YOUR BASE

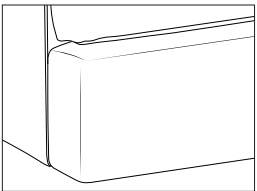

**Plain**  
*Hidden Leg\**

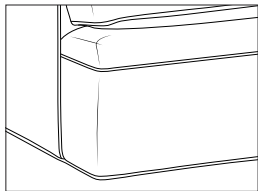

**Banded**  
*Hidden Leg\**

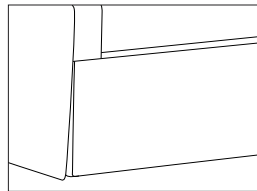

**S-Flounce Skirt**  
*Hidden Leg\**

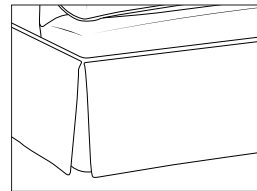

**T-Flounce Skirt**  
*Hidden Leg\**

**Plain**  
*Exposed Leg\*\**

**Banded**  
*Exposed Leg\*\**

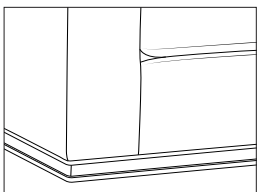

**Molded Wood Base**  
**UPCHARGE**

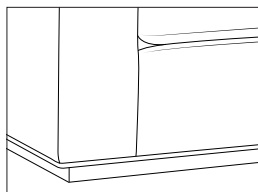

**Recessed Wood Plinth Base**  
**UPCHARGE**

\*Hidden leg finish is Black Walnut.

\*\*Choose leg and base wood finish at step 4. Base is shortened proportionally to exposed leg height.

## STEP 4: CHOOSE YOUR LEG AND WOOD FINISH

### EXPOSED LEG OPTIONS

Select your leg design below. Available options correspond to the arm style selected in Step 2.

#### 4" Arms, Dorset & Grand Arms

3.5"W x 2"H

- BLOCK
- TAPER (1/2" SMALLER AT BOTTOM)

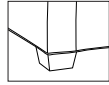
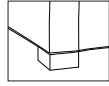

3.5"W x 3.5"H

- BLOCK
- TAPER (1" SMALLER AT BOTTOM)

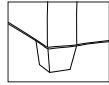
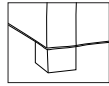

3.5"W x 5"H

- TAPER (1/4" SMALLER AT BOTTOM)

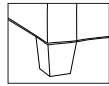

#### 6" Arms & Sock Arm

5.5"W x 2"H

- BLOCK
- TAPER (1/2" SMALLER AT BOTTOM)

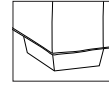
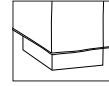

5.5"W x 3.5"H

- BLOCK
- TAPER (1" SMALLER AT BOTTOM)

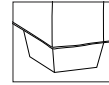
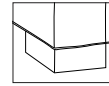

5.5"W x 5"H

- TAPER (1/4" SMALLER AT BOTTOM)

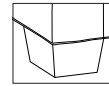

#### 9" Track Arm

8.5"W x 2"H

- BLOCK
- TAPER (1/2" SMALLER AT BOTTOM)

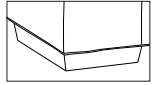
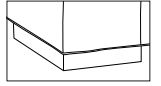

8.5"W x 3.5"H

- BLOCK
- TAPER (1" SMALLER AT BOTTOM)

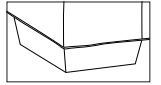
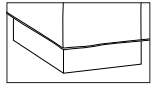

8.5"W x 5"H

- TAPER (1/4" SMALLER AT BOTTOM)

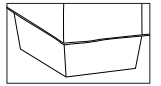

**Note:** Listed dimensions reflect overall leg measurements and may vary slightly due to handcrafted construction.

### WOOD FINISH OPTIONS







Select one finish for your exposed base or legs. Hidden legs are finished in Black Walnut.

*Finish images are for reference only. Each handcrafted finish will vary. Please refer to physical samples for the most accurate representation.*

#### Standard Wood Finishes

 <b>NEW</b>	 <b>NEW</b>	 <b>NEW</b>	 <b>NEW</b>		
<input type="checkbox"/> Dove	<input type="checkbox"/> Salt	<input type="checkbox"/> Seal	<input type="checkbox"/> Fawn	<input type="checkbox"/> Slate	<input type="checkbox"/> Antique Brown
 <b>NEW</b>	 <b>NEW</b>	 <b>NEW</b>			
<input type="checkbox"/> River Rock	<input type="checkbox"/> Charcoal	<input type="checkbox"/> Iron	<input type="checkbox"/> Umber	<input type="checkbox"/> Black Walnut	

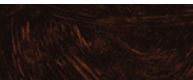
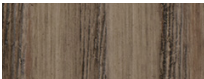
#### Premium Wood Finishes UPCHARGE

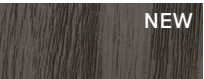
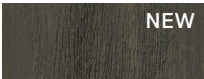
 <b>NEW</b>				
<input type="checkbox"/> Alabaster	<input type="checkbox"/> Linen	<input type="checkbox"/> Sand	<input type="checkbox"/> French Walnut	<input type="checkbox"/> Old Oak
		 <b>NEW</b>	 <b>NEW</b>	
<input type="checkbox"/> Cavalier	<input type="checkbox"/> Rustic Gray	<input type="checkbox"/> Pumice	<input type="checkbox"/> Graphite	

## STEP 5: CHOOSE YOUR SEAT SHAPE & SEAT FILL

Select welting options at step 8. Contrast welting subject to upcharge.

### SEAT SHAPE

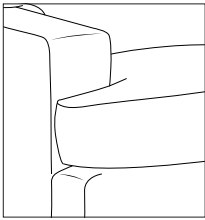

T-Cushion

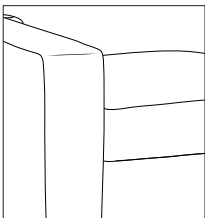

Square Cushion

### SEAT FILL

**Cloud 9 (Standard Fill)**

High-resiliency (HR) foam wrapped in two layers of D91, a specialty hollow-core polyester fiber designed for softness and recovery. Encased in a down-proof cover, this is our most popular cushion fill, featuring a distinctive crown and a plush sitting experience.

**Luxe Aire (No Additional Charge)**

Firmer HR foam wrapped in polyester fiber, which is then encased with a fabric cover. Luxe Aire offers a clean and tidy silhouette due to its firmer sit with minimal crown and is recommended for large bench seats if minimizing fabric wrinkles is desired.

**Down Supreme (Upcharge)**

HR foam core encased in a channeled, down-proof envelope filled with 90% feather and 10% down. This option delivers both supportive comfort and an indulgent feel. Regular fluffing is recommended to maintain loft and minimize comfort wrinkles that naturally occur with feather and down fills.

**Spring Down (Upcharge)**

A \*Marshall (pocket coil) spring system, wrapped in foam and encased in a down-proof envelope filled with a blend of 90% feather and 10% down. Combines resilient internal support with the softness of feather and down for a refined sitting experience.

**Trillum (Upcharge)**

HR foam core encased in a channeled, down-proof envelope that is filled with 100% synthetic fiber. A hypoallergenic alternative to natural down and feather, this cushion offers a soft, luxurious feel with great recovery and minimal maintenance.



## STEP 6: CHOOSE YOUR BACK SHAPE & BACK FILL

Select welting options at step 8. Contrast welting subject to upcharge.

### BACK SHAPE

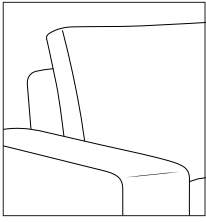

Square Boxed

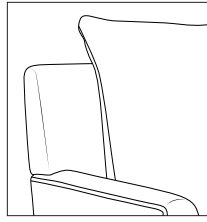

Knife Edge

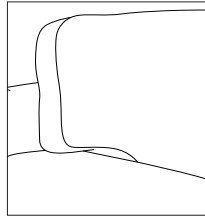

T-Boxed

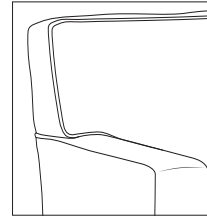

Tight Boxed\*

### BACK FILL \*BACK FILL CANNOT BE SELECTED WHEN TIGHT BOXED IS CHOSEN

**Blend Down (Standard Fill)**

A balanced blend of 50% polyester fiber, 45% feather, and 5% down, enclosed in a channeled, down-proof cover. This is our standard back cushion fill for most styles, offering inviting support and a comfortably weighted feel.

**Regalaire (No Additional Charge)**

A firmer fill of 100% polyester fiber, enclosed in a non-channeled, down-proof cover. Provides supportive, structured comfort.

**Down Supreme (Upcharge)**

A luxurious fill of 90% feather and 10% down, enclosed in a channeled, down-proof cover. Delivers plush, indulgent comfort with a natural loft.

**Trillium (Upcharge)**

A hypoallergenic alternative featuring soft, blown synthetic fiber inside a channeled, down-proof cover. Mimics the plush comfort of feather and down with less maintenance.

## STEP 7: CHOOSE YOUR FABRIC OR LEATHER

Any fabric from our Burton James collection, COM, or COL can be used. Refer to price list for pricing.

PATTERN: \_\_\_\_\_

COLOR: \_\_\_\_\_

## STEP 8: FINISHING TOUCHES

### WELTING

#### 1. SELECT WELT TYPE

- NONE       SELF WELT       CONTRAST WELT UPCHARGE  
*(Provide fabric details below)*

#### 2. SPECIFY WELT LOCATION

- BODY ONLY**      **CUSHIONS ONLY**       **ALL OVER**  
*(Includes all body areas and all cushions)*
- BASE       SEAT CUSHIONS  
 ARMS       BACK CUSHIONS  
 BACK

#### 3. SELECT WELT SIZE

- 1/4" STANDARD WELT       1/8" MICRO WELT

**Note:** There is no upcharge for self welt details in Alternatives. Contrast welt applied to the Body is charged as a single upcharge, regardless of the number of Body locations selected. Contrast welt applied to Seat Cushions and Back Cushions is charged per cushion category. The All Over option reflects built-in savings compared to selecting categories individually.

Please refer to Section T of the price list for contrast welt upcharges by fabric grade. When possible, include a diagram to ensure welting details are applied correctly.

**CONTRAST WELT FABRIC** *(Required if Contrast Welt is selected)*

PATTERN: \_\_\_\_\_ COLOR: \_\_\_\_\_

### NAILHEADS UPCHARGE | STANDARD DOES NOT INCLUDE NAILHEADS

**Nailhead Size** SHOWN TO SCALE | PICK ONE

- None       Small: 7/16"       Medium: 3/4"       Large: 1"

**Nailhead Finish** 7/16" SHOWN | PICK ONE

- FRENCH NATURAL       PEWTER       NICKEL       BRIGHT GOLD       ANTIQUE BRASS       BLACK PEARL       BRONZE

**Nailhead Spacing**

- HEAD-TO-HEAD       ONE ON, ONE OFF

**Nailhead Location**

- ARMS       BODY/BASE

# STEP 9: CHOOSE YOUR SECTIONAL PIECES

L-shaped sofas can only be combined with other L-shaped sofa pieces.



## OVERALL DEPTH

- 36" (20" Seat Depth)
- 38" (22" Seat Depth)
- 40" (24" Seat Depth)

## OVERALL HEIGHT

- 34"
- 36"
- 38"

**KEY:**

-  ARMS
-  BACK
-  THROW PILLOW

## SOFAS/CHAIR

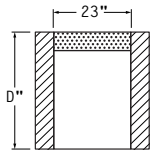

**#10**  
**CHAIR**  
23" + ARMS

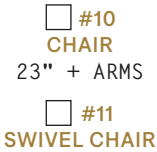

**#11**  
**SWIVEL CHAIR**  
(UPCHARGE)  
23" + ARMS

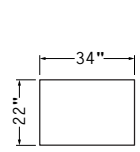

**#00**  
**OTTOMAN**  
34"

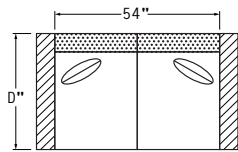

**#20**  
**54" LOVESEAT**  
54" + ARMS

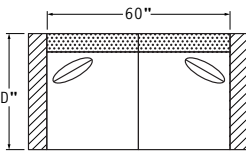

**#22**  
**60" SMALL SOFA**  
60" + ARMS

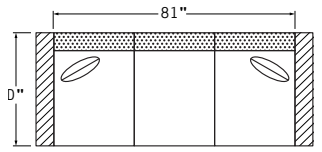

**#30**  
**81" SOFA**  
81" + ARMS

## L-SHAPED SOFAS

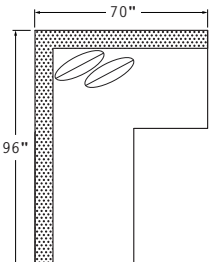

**#140** LSC ARMLESS

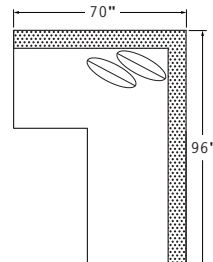

**#141** RSC ARMLESS

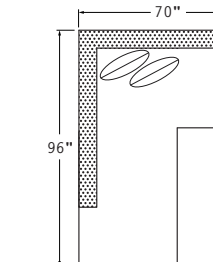

**#142** LSC BUMPER

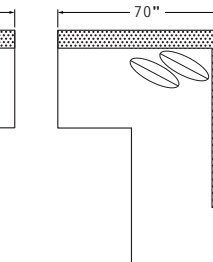

**#143** RSC BUMPER

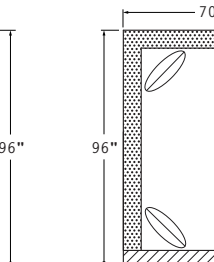

**#144** LAF/LSC

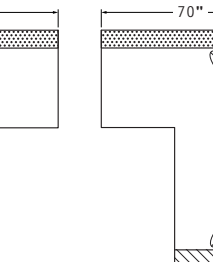

**#145** RAF/RSC

## LEFT ARM

## RIGHT ARM

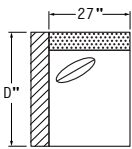

**#61**  
**LEFT ARM FACING/  
RIGHT SIDE ARMLESS**  
27" + ARM

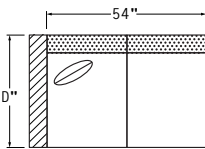

**#62**  
**LEFT ARM FACING/  
RIGHT SIDE ARMLESS**  
54" + ARM

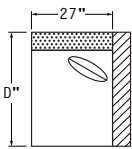

**#71**  
**RIGHT ARM FACING/  
LEFT SIDE ARMLESS**  
27" + ARM

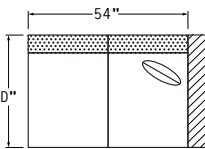

**#72**  
**RIGHT ARM FACING/  
LEFT SIDE ARMLESS**  
54" + ARM

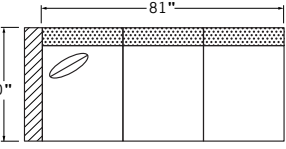

**#63**  
**LEFT ARM FACING/  
RIGHT SIDE ARMLESS**  
81" + ARM

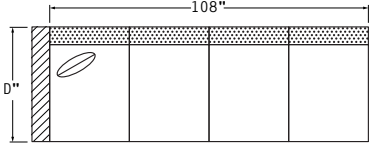

**#84**  
**LEFT ARM FACING/  
RIGHT SIDE ARMLESS**  
108" + ARM

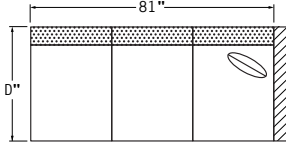

**#73**  
**RIGHT ARM FACING/  
LEFT SIDE ARMLESS**  
81" + ARM

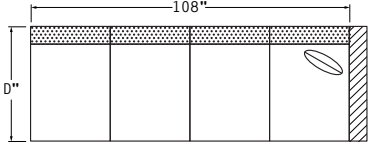

**#94**  
**RIGHT ARM FACING/  
LEFT SIDE ARMLESS**  
108" + ARM

## ARMLESS

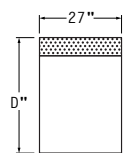

**#81**  
**1-CUSHION  
ARMLESS**  
27"

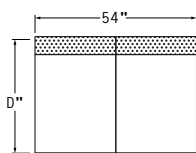

**#82**  
**2-CUSHION  
ARMLESS**  
54"

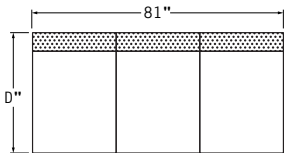

**#53**  
**3-CUSHION  
ARMLESS**  
81"

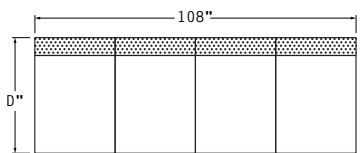

**#04**  
**4-CUSHION  
ARMLESS**  
108"

**CORNER/LEFT ARM**

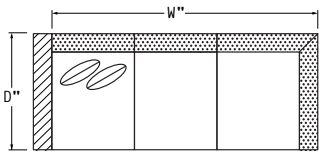

#23  
LEFT ARM FACING/  
RIGHT SIDE CORNER  
90"/92"/94" + ARM

**CORNER/RIGHT ARM**

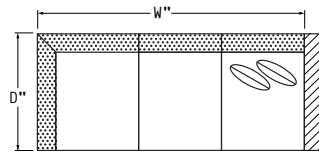

#33  
RIGHT ARM FACING/  
LEFT SIDE CORNER  
90"/92"/94" + ARM

**CORNERS**

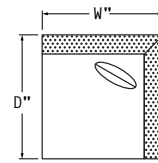

#41  
CORNER  
36"/38"/40"

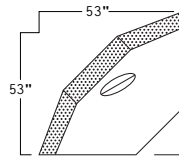

#87  
WEDGE CORNER  
53"

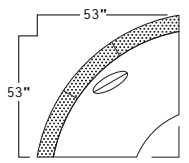

#86  
CURVE CORNER  
53"

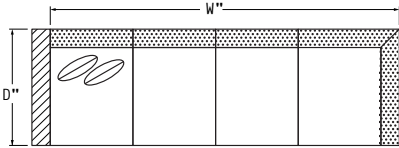

#24  
LEFT ARM FACING/  
RIGHT SIDE CORNER  
117"/119"/121" + ARM

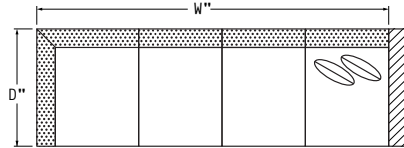

#34  
RIGHT ARM FACING/  
LEFT SIDE CORNER  
117"/119"/121" + ARM

**SECTIONAL TABLE**

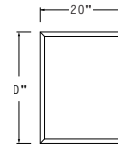

#108  
SECTIONAL TABLE  
Select finish at step 10

**CHAISE/LEFT ARM**

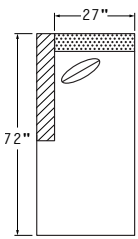

#74  
LEFT ARM FACING/  
RIGHT SIDE ARMLESS  
27" + ARM

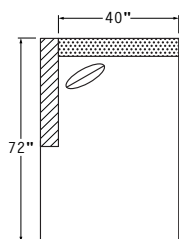

#76  
LEFT ARM FACING/  
RIGHT SIDE ARMLESS  
40" + ARM

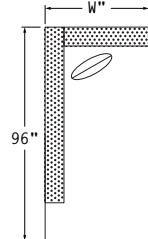

#99 LFBC  
LEFT FACING  
BUMPER CHAISE

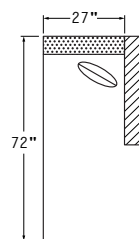

#64  
RIGHT ARM FACING/  
LEFT SIDE ARMLESS  
27" + ARM

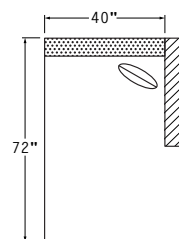

#66  
RIGHT ARM FACING/  
LEFT SIDE ARMLESS  
40" + ARM

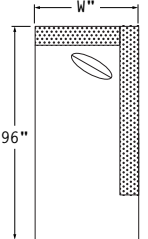

#89 RFBC  
RIGHT FACING  
BUMPER CHAISE

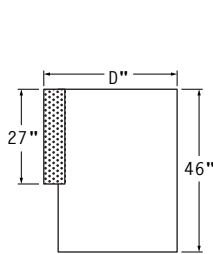

#75  
LEFT BUMPER  
46"

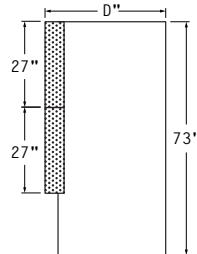

#77  
LEFT BUMPER  
73"

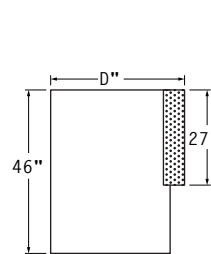

#65  
RIGHT BUMPER  
46"

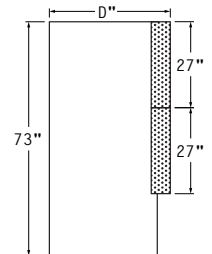

#67  
RIGHT BUMPER  
73"

**CORNERS/ARMS**

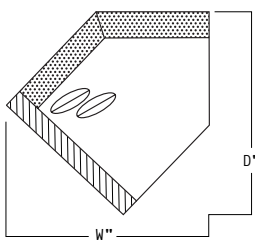

#68  
LEFT ARM FACING POD  
71"/73"/75"

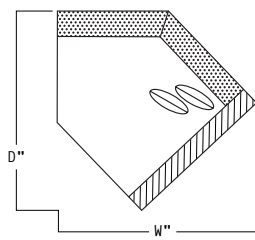

#78  
RIGHT ARM FACING POD  
71"/73"/75"

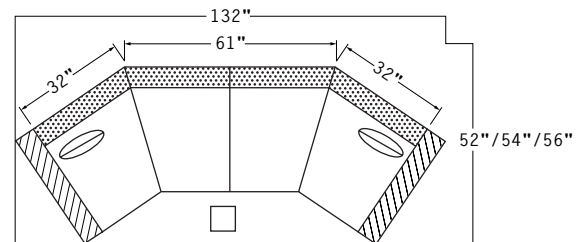

#85  
ANGLE SOFA  
132"

## STEP 10: SECTIONAL TABLE

Finish images are for reference only. Each handcrafted finish will vary. Please refer to physical samples for the most accurate representation.

### Specialty Finishes

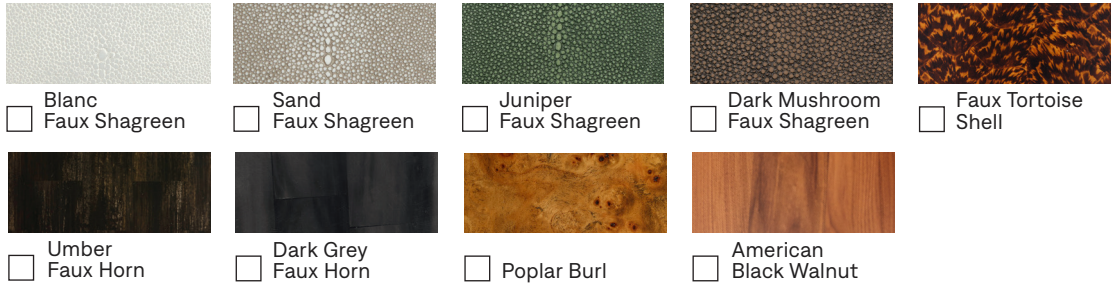

### Standard Wood Finishes

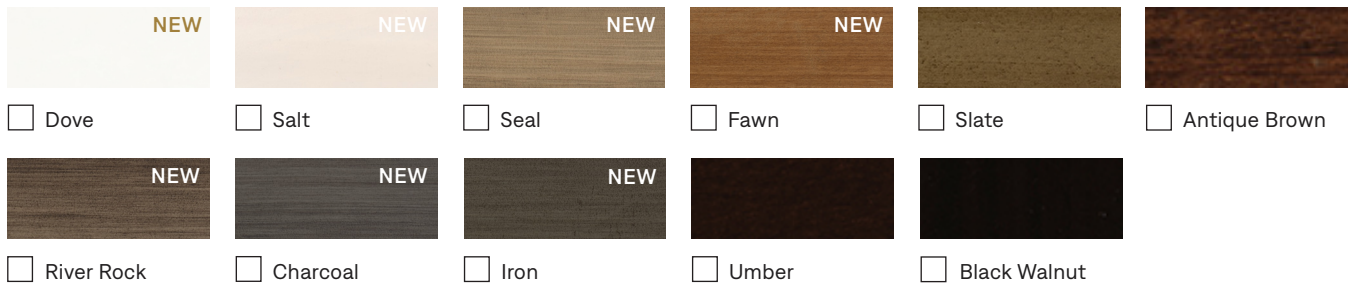

### Premium Wood Finishes UPCHARGE



Finish options shown on this page apply to the top surface only. For sectionals with a tapered leg design (selected in Step 4), the optional sectional table component includes hidden legs finished in Black Walnut, which may differ from the visible leg finish chosen in Step 4. For sectional designs with molded or recessed bases, the sectional table base will match the style and finish selected in Step 4.



# BURTON JAMES

burtonjames.com · 626 961 7221 · info@burtonjames.com